

CAP-C

Multi-Nozzle Diffuser

Data Sheet



Table of Contents

| | |
|---|---|
| Description | 1 |
| Design | 2 |
| Dimensions | 4 |
| Ordering Code | 5 |
| Technical Parameters | 6 |
| Installation, Maintenance & Operation | 8 |
| Transport & Storage | 8 |
| Supplement | 8 |
| Related Product | 8 |



Description

CAP-C is a multi-nozzle diffuser with a plenum box, mainly intended for air supply in comfort ventilation systems for offices, shops, medical rooms, school classrooms, etc., installed in open space under the ceiling.

Highlights

- Versatile adjustability of air discharge patterns
- Excellent air induction and mixing even with small air flow volumes, fit for VAV ventilation
- High air flow capacity with low noise and moderate pressure drop
- Compact design with adjustment damper and flow measurement probes for supply and extract

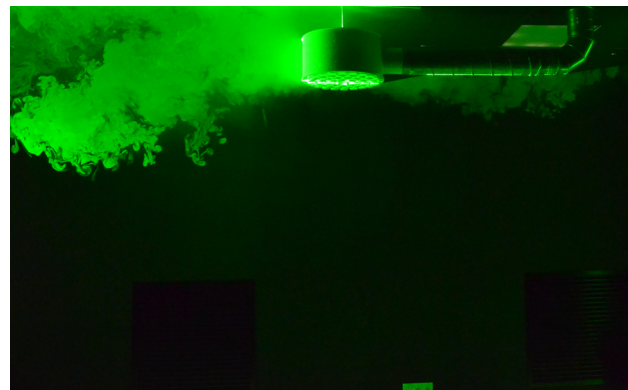
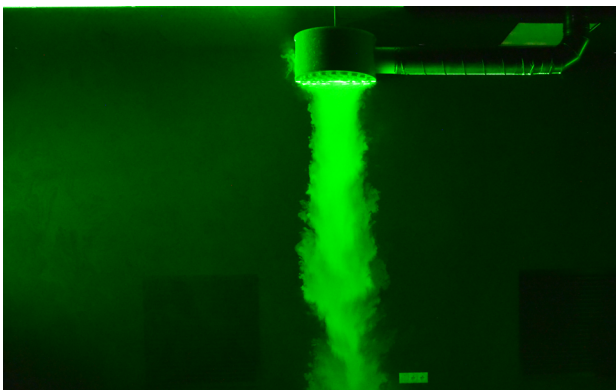

Fig. 1: Air flow visualisation (left: vertical discharge pattern; right: horizontal discharge pattern)

Design

The CAP-C body is made from galvanized steel, composed of the plenum box with a sideways oriented rubber gasket sealed circular connection and diffuser plate with polymer nozzles, attached by permanent magnets. The nozzles can be rotated by 360° in the plane of the diffuser plate. The proper directional adjustment of the individual nozzles results in the desired air discharge pattern. The connection spigot is equipped with an air flow adjustment damper and the air flow measurement probe tapings for air supply and extract. All these parts are accessible from outside, so measurement and adjustment require no dismantling of the diffuser. For the installation of the diffuser, there is a thread nut in the upper part of the plenum box. It is fit for fixing on the suspended thread bar.

Product Parts

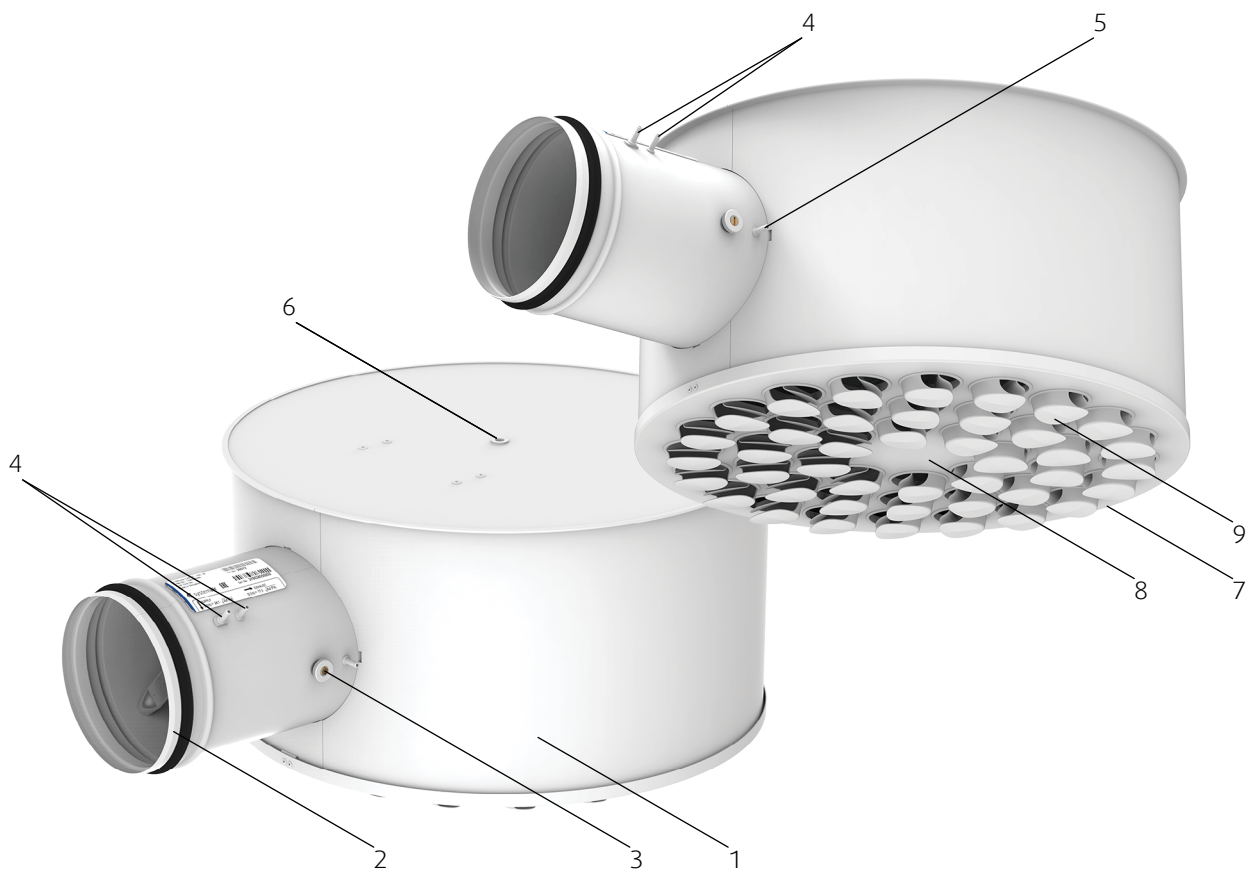

Fig. 2: Components of CAP-C

Legend

| | |
|---|----------------------------------|
| 1 | Plenum box |
| 2 | Connection with rubber gasket |
| 3 | Damper (adjustable from outside) |
| 4 | Supply air measurement tapping |
| 5 | Extract air measurement tapping |
| 6 | Nut M8 for fixing on thread bar |
| 7 | Magnets to hold diffuser plate |
| 8 | Diffuser plate |
| 9 | Nozzles |

Setup Possibilities

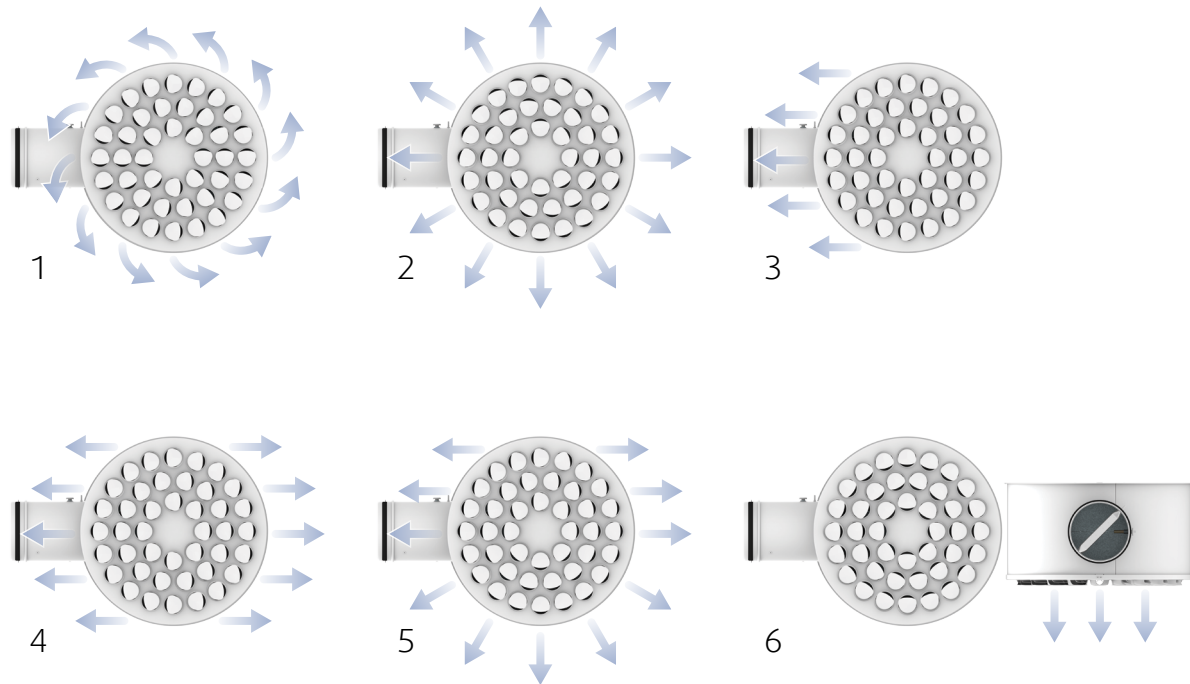

Fig. 3: Different deflector setup and resulting air discharge patterns

Legend

| | |
|---|---|
| 1 | Tangential horizontal swirl discharge |
| 2 | Radial horizontal omnidirectional discharge |
| 3 | Horizontal discharge, single direction |
| 4 | Horizontal discharge, 2 directions |
| 5 | Horizontal discharge, 3 directions |
| 6 | Vertical discharge |

Dimensions

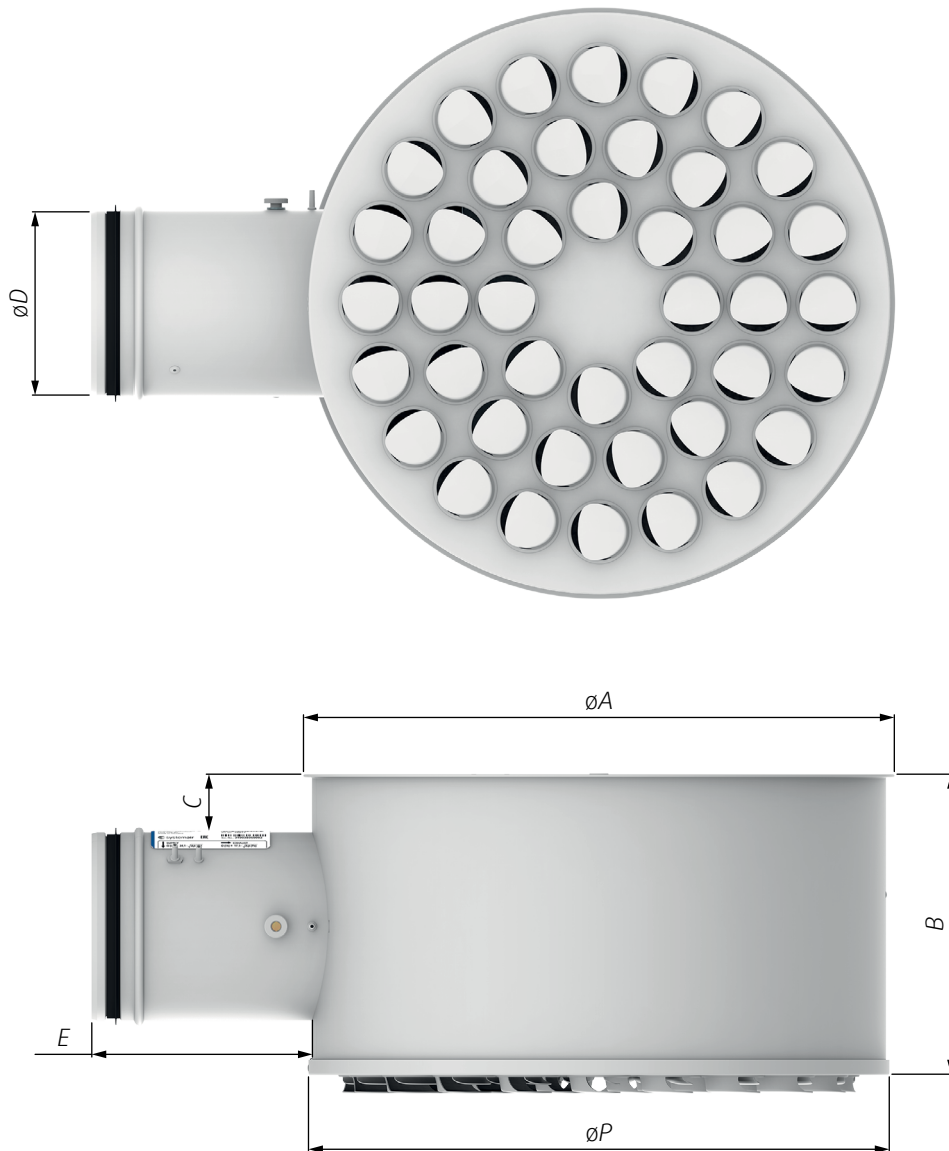

Fig. 4: Dimensions of CAP-C

Tab. 1: Dimensions of CAP-C

| Type | $\varnothing D$ | $\varnothing A$ | $\varnothing P$ | B | C | E | m |
|-----------|-----------------|-----------------|-----------------|-----|-----|-----|------|
| | mm | | | | | | kg |
| CAP-C-100 | 98 | 324 | 314 | 172 | 39 | 155 | 3,0 |
| CAP-C-125 | 123 | 408 | 398 | 202 | 41 | 165 | 4,4 |
| CAP-C-160 | 158 | 497 | 487 | 252 | 49 | 185 | 6,8 |
| CAP-C-200 | 198 | 597 | 587 | 287 | 46 | 210 | 9,2 |
| CAP-C-250 | 248 | 608 | 598 | 332 | 44 | 235 | 10,6 |
| CAP-C-315 | 313 | 632 | 622 | 422 | 56 | 265 | 13,3 |

Ordering Code

| | | | | |
|---------------------------------|----------------------|---------|--------------------------|--------------------------|
| | | CAP-C- | <input type="checkbox"/> | <input type="checkbox"/> |
| | | 100 | | |
| | | 125 | | |
| | | 160 | | |
| | | 200 | | |
| | | 250 | | |
| | | 315 | | |
| Size - inlet \varnothing (mm) | | | | |
| | RAL9003 signal white | SW | | |
| | RAL9010 white | W | | |
| Surface finish ¹⁾ | Other RAL colour | RALXXXX | | |

NOTE: 1) If no colour is stated in the ordering code, the diffuser will be delivered in the RAL 9003 signal white colour.

Example of the Ordering Code

CAP-C-200-SW

Diffuser of size 200mm, signal white colour.

Technical Parameters

Legend

| | | |
|------------|------------------------|---|
| P_s | Pa | Pressure drop |
| q_v | m ³ /h, l/s | Air flow volume |
| L_{WA} | dB(A) | A-weighted total sound power level |
| L_w | dB | Non-weighted total sound power level |
| ΔT | K | Temperature difference Supply air - Room air |
| $L_{0,2}$ | m | Air throw length with terminal velocity 0,2 m/s |

| | | |
|--|-----|---|
| L_x | m | Air throw length calculated for specific terminal velocity |
| x | m/s | Terminal velocity in range of 0,1 m/s ... 1 m/s |
| \updownarrow 0%, \updownarrow 25%, 50%, 75%, \updownarrow 100% | | The plenum box damper positions in pressure drop/ noise diagrams are represented as a percentage. \updownarrow 0% is a fully closed damper. \updownarrow 100% is a fully open damper. |

Calculation of Air Throw for Different Terminal Velocities

$$L_x = L_{0,2} \times 0,2/x$$

Correction Tables

NOTE: For vertical distribution see Systemair DESIGN.

Tab. 2: Correction factors for horizontal distribution

| | |
|--------------------|-------------------|
| $\Delta T = -10$ K | $\Delta T = 10$ K |
| 0,75 | 0,83 |

Tab. 3: Correction factors for horizontal distribution - alternative nozzle settings

| | | | |
|-------|-------|-------|-------|
| 4 way | 3 way | 2 way | 1 way |
| 1,40 | 1,90 | 2,30 | 3,30 |

e.g.: $L_{(\Delta T = 10\text{ K})} = L_{(\Delta T = 0\text{ K})} \times 0,83$

e.g. for 3 way horizontal diffusion: $L_{0,2 (3\text{ way})} = L_{0,2 (radial)} \times 1,9$

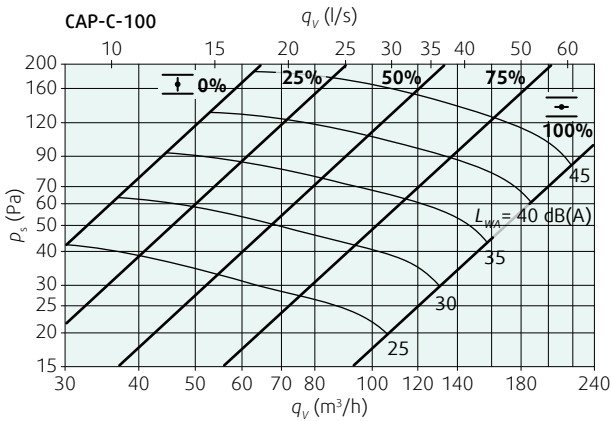

Diagram 1: Pressure drop & A-weighted total sound power level depending on air flow volume

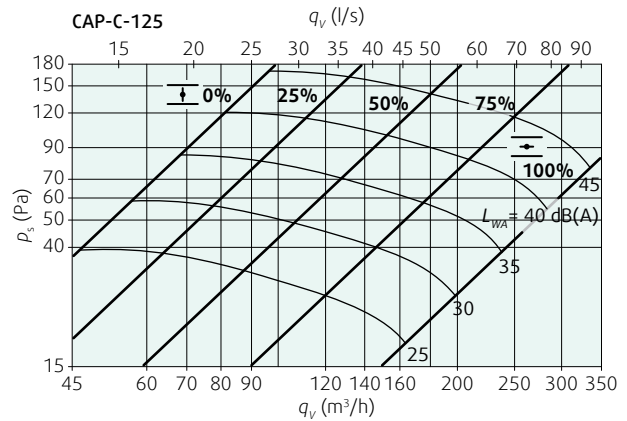

Diagram 3: Pressure drop & A-weighted total sound power level depending on air flow volume

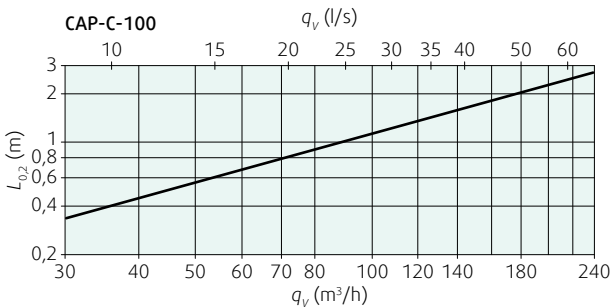

Diagram 2: Isothermal air throw lengths for horizontal radial discharge with terminal velocity 0,2 m/s, depending on air flow volume

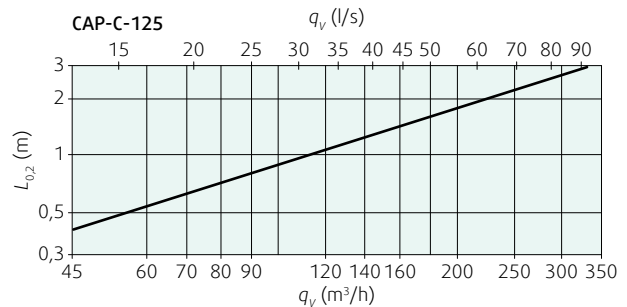

Diagram 4: Isothermal air throw lengths for horizontal radial discharge with terminal velocity 0,2 m/s, depending on air flow volume

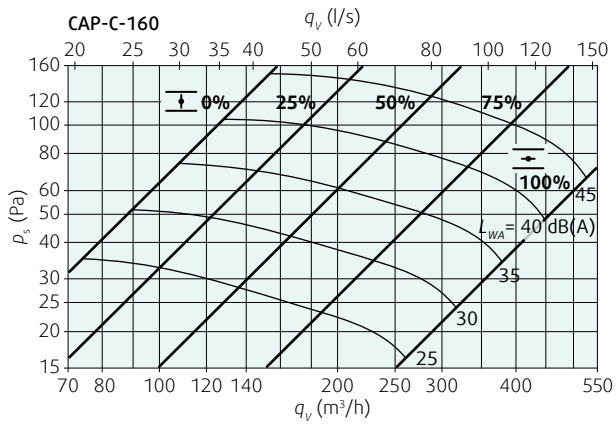

Diagram 5: Pressure drop & A-weighted total sound power level depending on air flow volume

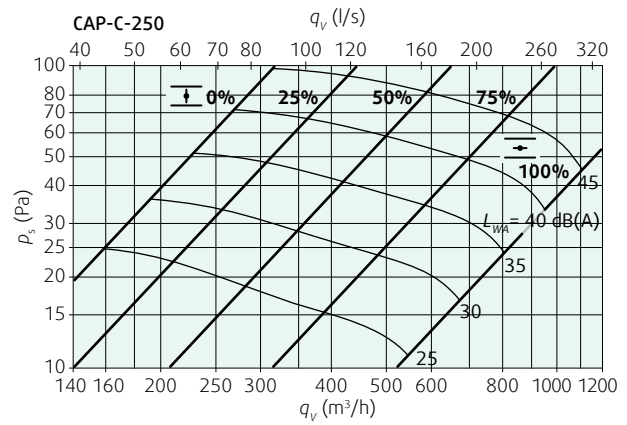

Diagram 9: Pressure drop & A-weighted total sound power level depending on air flow volume

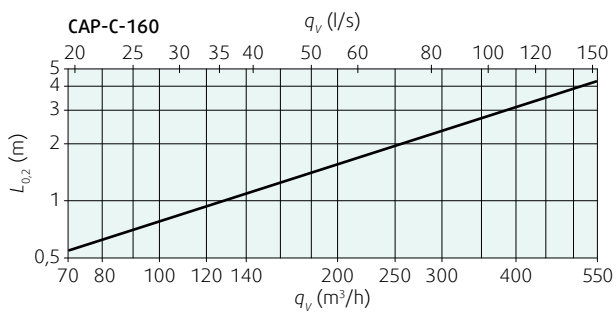

Diagram 6: Isothermal air throw lengths for horizontal radial discharge with terminal velocity 0,2 m/s, depending on air flow volume

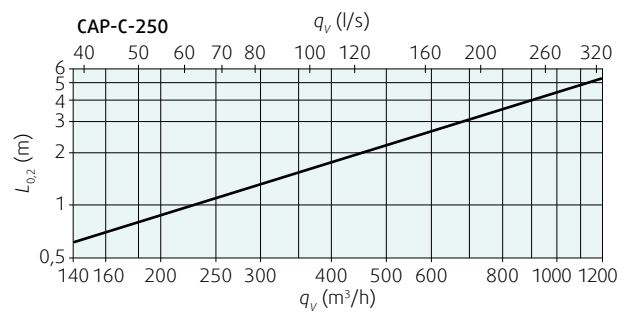

Diagram 10: Isothermal air throw lengths for horizontal radial discharge with terminal velocity 0,2 m/s, depending on air flow volume

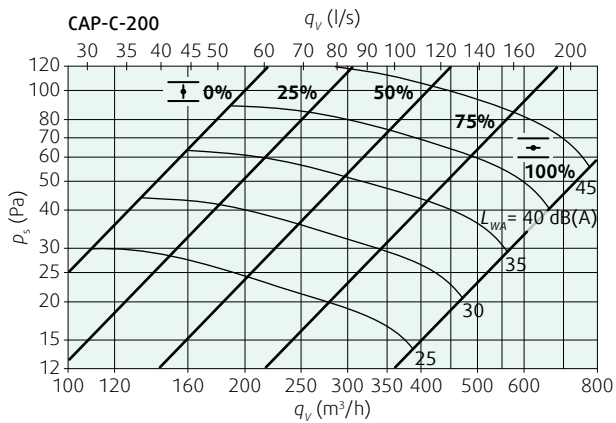

Diagram 7: Pressure drop & A-weighted total sound power level depending on air flow volume

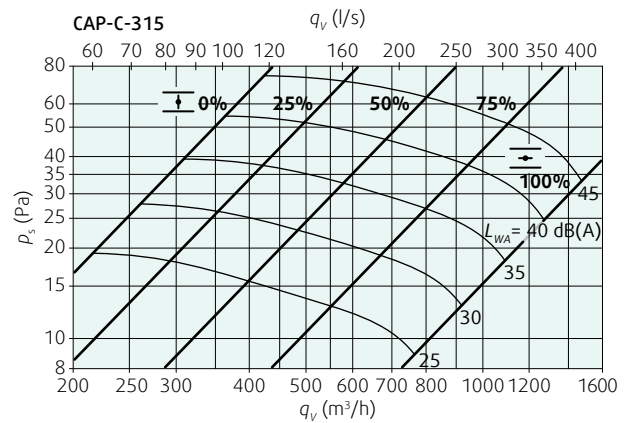

Diagram 11: Pressure drop & A-weighted total sound power level depending on air flow volume

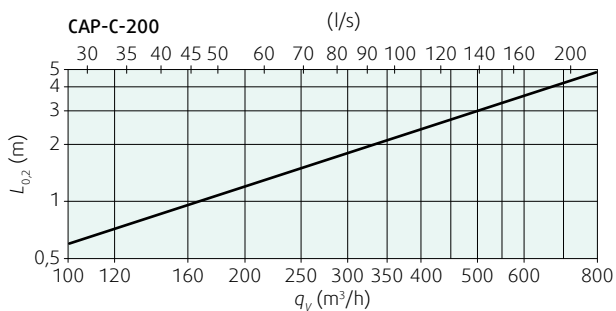

Diagram 8: Isothermal air throw lengths for horizontal radial discharge with terminal velocity 0,2 m/s, depending on air flow volume

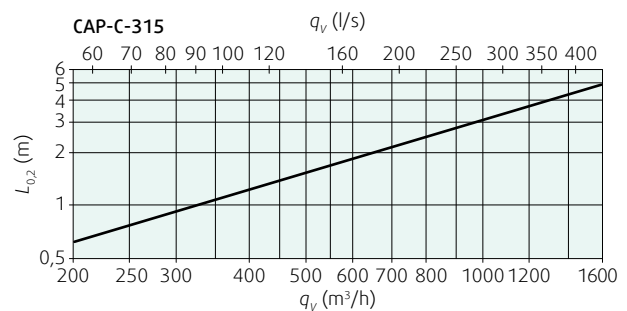

Diagram 12: Isothermal air throw lengths for horizontal radial discharge with terminal velocity 0,2 m/s, depending on air flow volume

Installation, Maintenance & Operation

Information about installation, maintenance and operation is available in the “UserManual_CAP-C” document.

Transport & Storage

Dry indoor conditions with a temperature range of -40°C to +50°C.

Supplement

Any deviations from the technical specifications contained herein and the terms should be discussed with the manufacturer. We reserve the right to make any changes to the product without prior notice, provided that these changes do not affect the quality of the product and the required parameters.

Current information on all products is available at www.systemair.com

Related Product

CAP-CT

Multi-Nozzle Diffuser

Product information is available within the technical documentation “DataSheet_CAP-CT” and at www.systemair.com



